

Technical data sheet

Product features



Electric range with static oven

Model	SAP Code	00008524
--------------	-----------------	----------



- Device type: Electric unit
- Type of internal part of the appliance 2 (eg oven): Static
- Protection of controls: IP24
- Material: AISI 304 top plate and cladding

SAP Code	00008524	Net Weight [kg]	122.90
Net Width [mm]	800	Power electric [kW]	13.100
Net Depth [mm]	730	Loading	400 V / 3N - 50 Hz
Net Height [mm]	900	Type of internal part of the appliance 2 (eg oven)	Static

Technical data sheet

Technical drawing



Electric range with static oven

Model

SAP Code

00008524

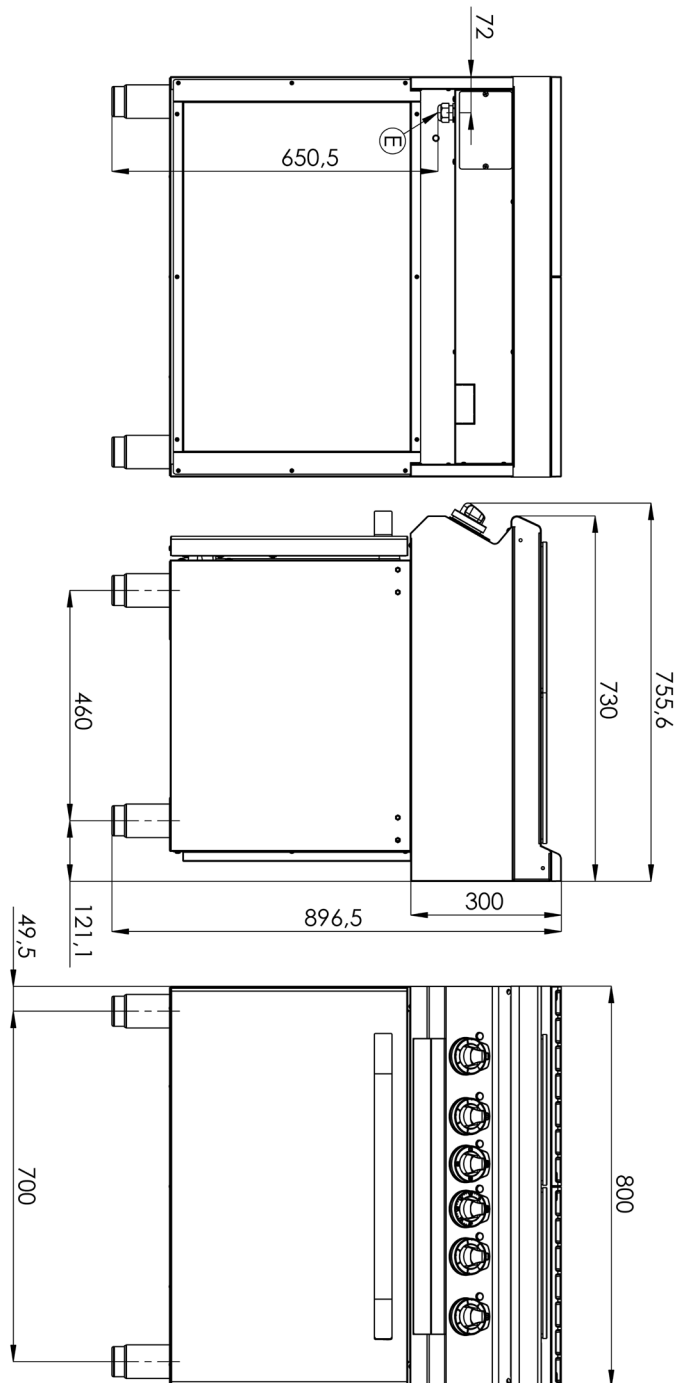

Technical data sheet

Product benefits



Electric range with static oven

Model	SAP Code	00008524
-------	----------	----------

1

Square

heat

Effective cooking on a large neighborhood

- saving time when preparing meals
- Easy to operate thanks to a large area

2

Internal thermostatic protection of the hob

a longer life of the hob

3

Degree of protection of controls IPX4

maintenance -free

water resistance

long life

- Savings on service interventions
- easy cleaning of the device

4

Nationheres

long life

Cut -made steel of 10 mm thick boards

- Savings on service interventions
- higher corrosion resistance

5

Hygienic embossments of the top plate

absence of sharp corners and edges (potential places where dirt could adhere)

smooth transitions

- Simple fast cleaning

6

Large El.Troubta with four positions for grates with static baking

static baking

high capacity and variability

nationheres

- Suitable for yeast dishes and desserts
- long life
- simple cleaning

Technical data sheet

Technical parameters



Electric range with static oven

Model

SAP Code

00008524

1. SAP Code:

00008524

2. Net Width [mm]:

800

3. Net Depth [mm]:

730

4. Net Height [mm]:

900

5. Net Weight [kg]:

122.90

6. Gross Width [mm]:

840

7. Gross depth [mm]:

800

8. Gross Height [mm]:

1080

9. Gross Weight [kg]:

132.00

10. Device type:

Electric unit

11. Construction type of device:

Stationary

12. Power electric [kW]:

13.100

13. Loading:

400 V / 3N - 50 Hz

14. Protection of controls:

IP24

15. Device color:

Stainless steel

16. Material:

AISI 304 top plate and cladding

17. Indicators:

operation

18. Worktop type:

Molded - comfortable cleaning maintenance

19. Worktop material:

AISI 304

20. Worktop Thickness [mm]:

1.50

21. Maximum device temperature [°C]:

400

22. Minimum device temperature [°C]:

50

23. Number of power control stages:

6

24. Service accessibility:

Trough the frontal panel

25. Adjustable feet:

Yes

26. Number of burners/hot plates:

4

27. Type of gas cooking zones:

Thales

28. Type of electric cooking zones:

Squared

Technical data sheet

Technical parameters



Electric range with static oven

Model

SAP Code

00008524

29. Oven Type:

electrical static

33. Gasket:

Yes

30. Oven power electric [kW]:

6.30

34. Maximum temperature of the inner chamber [°C]:

300

31. Oven size:

GN 2/1

35. Minimum temperature of the inner chamber [°C]:

50

32. Type of internal part of the appliance 2 (eg oven):

Static